



FITTING INSTRUCTIONS

NISSAN GU PATROL BULL BAR, 10/2004 ONWARDS (SRS AIR BAG EQUIPPED MODELS)

PRODUCT NUMBERS:

- 3217300 – Non winch bar to suit flared vehicles
- 3417300 – Winch bar to suit flared vehicles

- FITTING KITS: 6172339 – To suite winch bars (3417300)
 6172359 – To suite non-winch bar (3217300)

WARNING

FOR VEHICLES EQUIPPED WITH SRS AIRBAG
WHEN INSTALLED IN ACCORDANCE WITH THESE INSTRUCTIONS, THE FRONT PROTECTION BAR DOES NOT AFFECT OPERATION OF THE SRS AIRBAG.

TAKE NOTE OF THE FOLLOWING:

- THIS PRODUCT MUST BE INSTALLED EXACTLY AS PER THESE INSTRUCTIONS USING ONLY THE HARDWARE SUPPLIED.
- IN THE EVENT OF DAMAGE TO ANY BULL BAR COMPONENT, CONTACT YOUR NEAREST AUTHORISED ARB STOCKIST. REPAIRS OR MODIFICATIONS TO THE IMPACT ABSORPTION SYSTEM MUST NOT BE ATTEMPTED.
- DO NOT USE THIS PRODUCT FOR ANY VEHICLE MAKE OR MODEL, OTHER THAN THOSE SPECIFIED BY ARB.
- DO NOT REMOVE LABELS FROM THIS BULL BAR.
- THIS PRODUCT OR ITS FIXING MUST NOT BE MODIFIED IN ANY WAY.

OPTIONAL LIGHT SETS TO SUIT THIS PRODUCT:

- ARB 6821201 Fog Light Kit Suit 3163015
- Up to IPF 900 SERIES FOG OR DRIVING LIGHT SETS

USE	PART No	QTY	DESCRIPTION
CONTROL BOX FITMENT (winch bars only)	3756499	1	CONTROL BOX BRACKET
	6151020	2	BOLT M8 x 16mm
	4581044	2	WASHER FLAT M8
	6151132	2	NUT FLANGE M8
	EG50	2	GROMMET RUBBER
	180302	10	CABLE TIES
WINCH (8/9,000LB)	4581040	4	WASHER FLAT 3/8"
	6151074	4	BOLT UNC 3/8" x 1 3/4"
WINCH (10/12,000LB)	4581041	4	WASHER FLAT 7/16"
	6151079	4	BOLT UNC 7/16" x 1 1/2"
WINCH CABLES: 8, 9, 10 & 12000 LB	BLB560	3	CABLE BLACK 560mm
CHASSIS BRACKET TO BULL BAR	3756395L	1	BRACKET CHASSIS LHS
	3756395R	1	BRACKET CHASSIS RHS
	6151135	4	NUT M12
	6151095	4	BOLT M12 x 35mm
	4581050	4	WASHER SPRING 1/2"
	4581071	4	WASHER SHOULDER M12
	4581070	8	WASHER FLAT M12
	CHASSIS BRACKET TO CHASSIS	4581088	2
6151096		7	BOLT M12 x 1.25mm x 40mm
6151095		1	BOLT M12 x 1.25mm x 35mm
6151135		2	NUT M12 x 1.25mm
6151189		2	NUT M12 x 1.75mm
4581049		2	WASHER FLAT 1/2"x 1 1/8"
4581050		8	WASHER SPRING 1/2"
4581007		8	WASHER HEAVY DUTY 13mm
4581008		2	WASHER HEAVY DUTY OFFSET 13mm
6151087		2	BOLT M10 x 25mm x 1.25mm
6151133		2	NUT M10 x 1.25mm
4581040		4	WASHER FLAT M10
4581048		2	WASHER SPRING M10
BUFFERS		6151128	12
	3162470RS	1	BUFFER (RH)
	3162470LS	1	BUFFER (LH)
NO. PLATE	6151017	2	BOLT M6 x 16
	6151046	2	WASHER FLAT M6
	6151128	2	NUT FLANGE M6
AIR DEFLECTOR	6522047	1	AIR DEFLECTOR FRONT
	3314440	1	AIR DEFLECTOR EXTENSION
	6151017	10	BOLT M6 x 16mm
	6151046	10	WASHER FLAT M6
	6151128	7	NUT FLANGE M6
	6151315	3	NUT CAGE M6

INDICATORS TO BULL BAR

3163015	1	COMBINATION LIGHT SURROUND KIT
180701	6	SCOTCH LOCK
6821152	2	TURN SIGNAL/CLEARANCE LIGHT LOOM
6821151L	1	TURN SIGNAL/CLEARANCE LIGHT
6821151R	1	TURN SIGNAL/CLEARANCE LIGHT

TOOLS REQUIRED.

Basic tool kit: torque wrench, drill, 10mm drill bit, 14mm and 16mm stepped ring spanners.

ASSEMBLY SEQUENCE FOR BULL BAR INSTALLATION.



1. Fit buffers to bar using 6mm flange nuts.

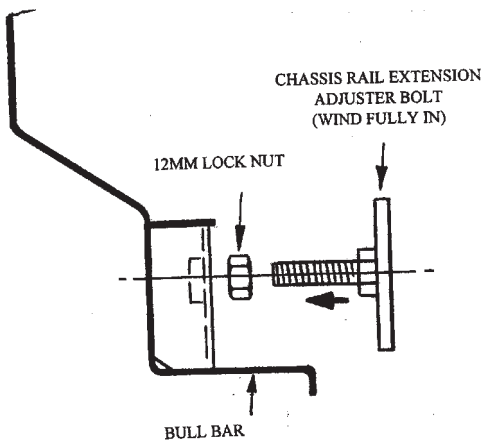



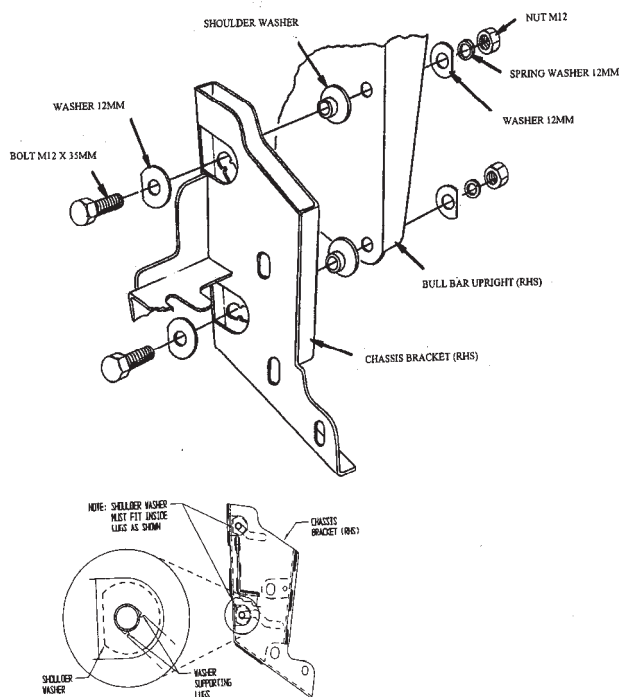

2. Rest the bar face down on two stands so assembly can be carried out.
3. Assemble a 12mm nut to each chassis rail extension adjuster bolt and fully screw into bull bar.
4. Do not tighten, as this will be adjusted later.



5. Assemble the two chassis brackets to the bull bar using two per side, M12 x 35mm bolts, heavy duty D washers, shoulder washers, heavy duty D washers, spring washers and nuts.

Position the impact absorbers centrally on the upright slots. These slots were provided to accommodate chassis height variations.

Tighten the bolts firmly; though do not fully tighten as they may be adjusted at step 31.

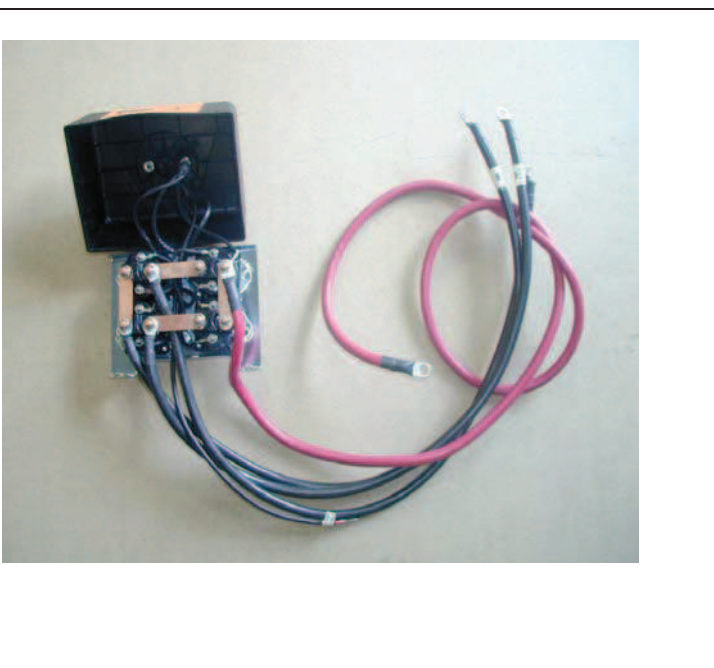
	<p>ORIGINAL</p>	<p><u>TO FIT A WINCH BAR</u></p> <p>(## If not fitting a winch proceed to step 20)</p> <p>6. To fit an 8/9/9.5/000lb winch, rotate gearbox 144° counterclockwise.</p> <p>7. Stand winch upright and undo the capped head screws and by lifting the gearbox only a couple of millimeters, rotate the gearbox. Once in position, refit all screws and tighten firmly.</p> <p>WARNING: Do not lift gearbox more than a couple of millimeters.</p>
	<p>VIEWED FROM LHS OF VEHICLE</p> <p>ROTATED</p>	
	<p>ORIGINAL</p>	<p>8. To fit a 10/12000 winch, rotate gearbox 72° clockwise.</p> <p>NOTE: Both winches are viewed from gearbox end and cable spools from the bottom of both winches.</p>
	<p>VIEWED FROM RHS OF VEHICLE</p> <p>ROTATED</p>	
	<p>9. Remove the cover from the control box.</p> <p>10. The three main power cables that go from winch to control box, plus main power cable from control box to battery must be changed over using longer cables from bolt kit. Make sure that you identify the colour codes on the new cables before closing control box cover.</p> <p>11. This must be done for whatever winch is to be fitted to the bull bar.</p>	

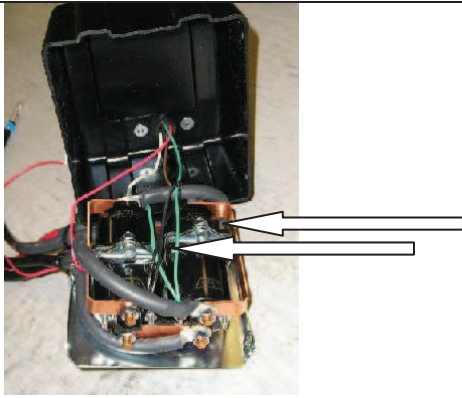

12. If fitting the **XP 9.5 winch**, remove the cover from the control box.

13. Remove the two cap screws, nuts and spacer washers that hold the four solenoids in place.

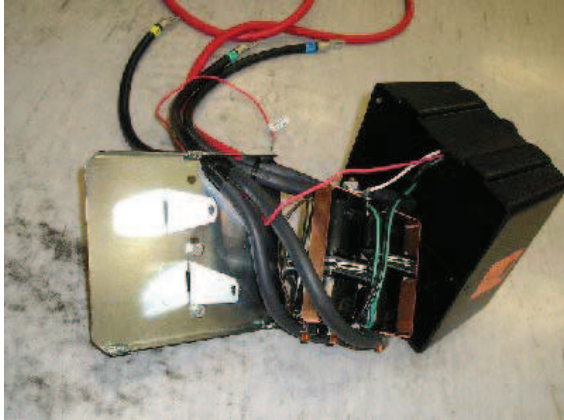

14. Remove the four solenoids from the base of the control box using the copper bus bar as an aid and hold to one side.

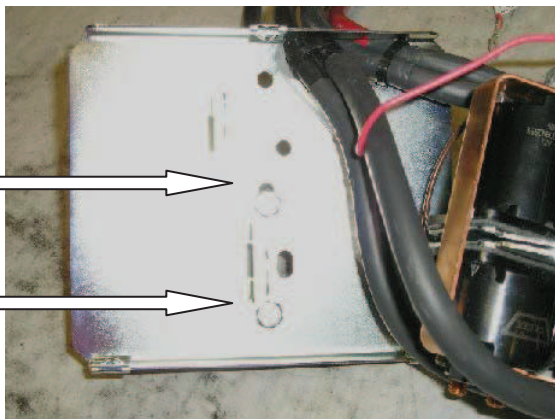

Before

15. Remove the two bolts in the base of the control box and reposition them into the more centralised holes.

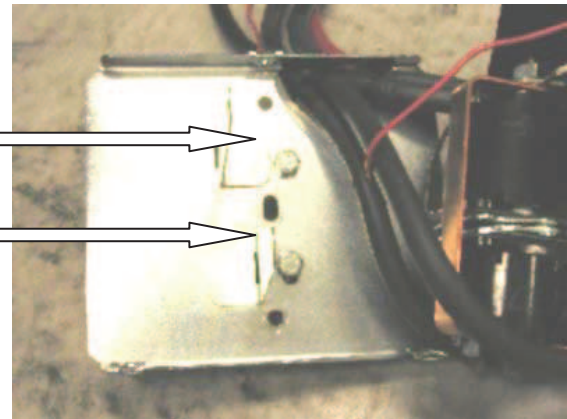

After

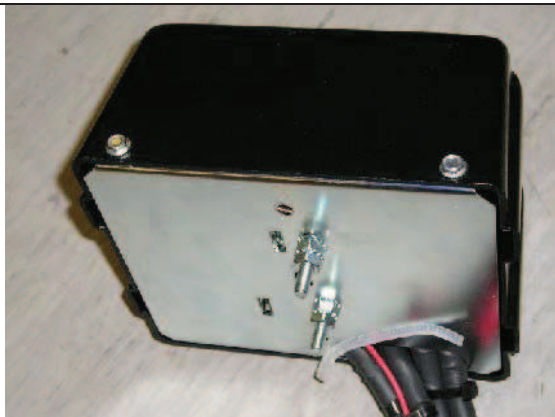

16. Place the 4 solenoids over the 2 metal stands that are facing upwards. Make sure they line up with the holes in the base.

17. Replace the 2 cap screws, washers and nuts removed in step 13 above into original holes.

18. Replace the black cover and refit the three cover screws (**DO NOT OVER TIGHTEN**)

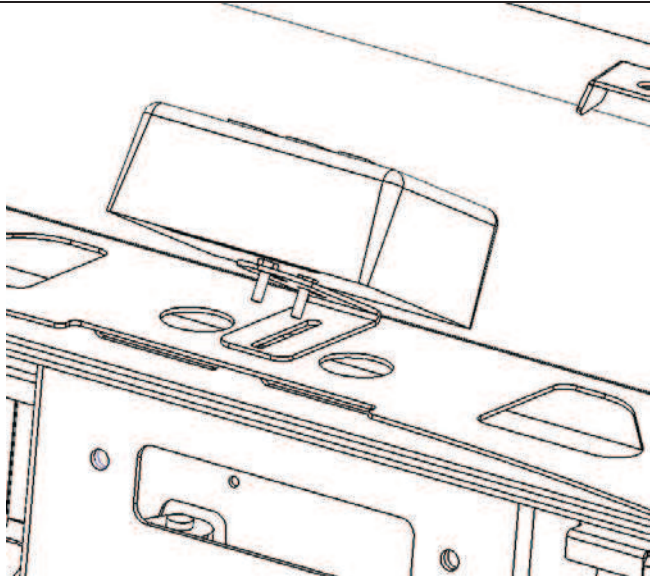

19. Bolt the control box bracket to the control box.

Fit the two grommets into the round holes then thread the cable through.

Mount the control box bracket onto the top pan, using M8 bolts, flat washers and flanged nuts. Use the cable ties to ensure the winch cables are secure, clear of moving parts and sharp edges and tie them together.



20. Place winch on a stand with mounting holes facing upwards and lower bull bar onto winch. Align all four holes and secure using 1 1/2" x 7/16" bolts, 7/16" spring washers and 7/16" flat washers on 10/12,000LB winch. When using 8/9,000LB winch, secure using 1 1/2" x 3/8" bolts on top holes and 1 3/4" x 3/8" bolts on lower holes, plus 3/8" spring and flat washers.

21. When all bolts are fitted and finger tight, centralize bolts in holes and tighten top holes only, using a stepped ring spanner.

22. Remove lower bolts.



23. Fit roller fairlead into cutout and refit bolts and tighten firmly.

NB. For ease of tightening lower bolts, use a stepped ring spanner to suit bolts size.

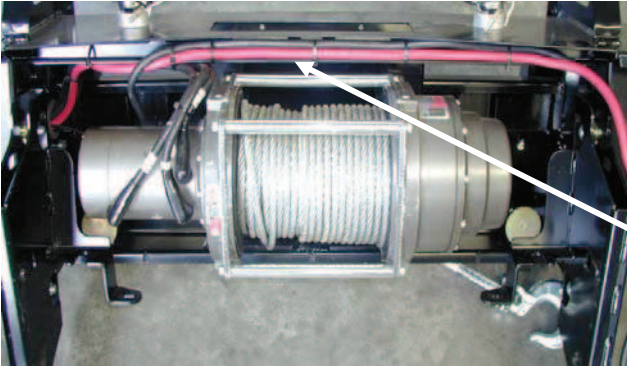

PHOTO ABOVE IS OF A 12 000LB WINCH.

- 24. Connect the winch control box cables to the winch. Refer to Warn installation instruction manual when wiring up winch.
- 25. Ensure that all cables are installed well clear of all sharp or moving parts, by using cables ties from bolt kit.
- 26. Cable tie main cables that go to battery in between underside of bar and brace.

Refer to photo to see where to cable tie to bull bar.

FUNCTION	INDICATOR HARNESS	VEHICLE COMBINATION LAMP	
		RIGHT	LEFT
TURN LAMP	GREEN	GREEN / RED	GREEN / YELLOW
EARTH	BLACK	BLACK	BLACK
PARK LAMP	RED	BLUE/BLACK	BLUE/BLACK

- 27. Remove the splash guards attached to the bumper and remove the bumper and grille from vehicle. This is done gently using a screw driver to remove the existing plastic fasteners.

- 28. Remove the vehicle's head lamps and then wire the indicator looms provided in the kit to the vehicle's indicator loom using scotch locks. Leave these new looms hanging freely for easy access when the bar is fitted and reattach the vehicle's head lamps and grille.

- 29. Position the bull bar on top of the chassis rails and bolt into place using the M12 x 40mm bolts, heavy-duty washers and spring washers. (Do not tighten)

NOTE: Due to variations in the vehicle chassis rails it may be necessary to place a packer between the chassis rail top and the bull bar. A heavy-duty washer is supplied for this purpose.

Refer to photo

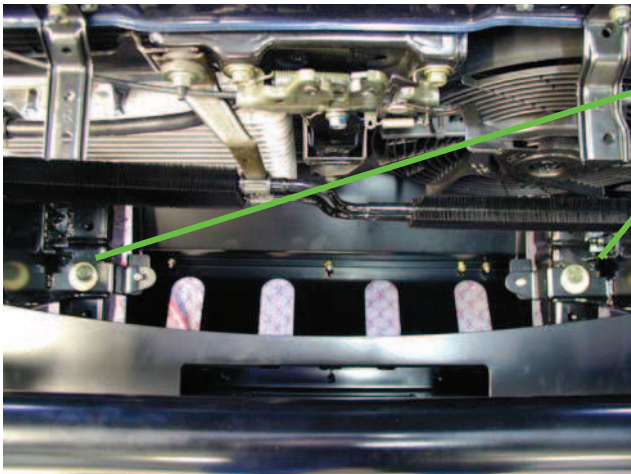

VIEWED FROM TOP OF BAR

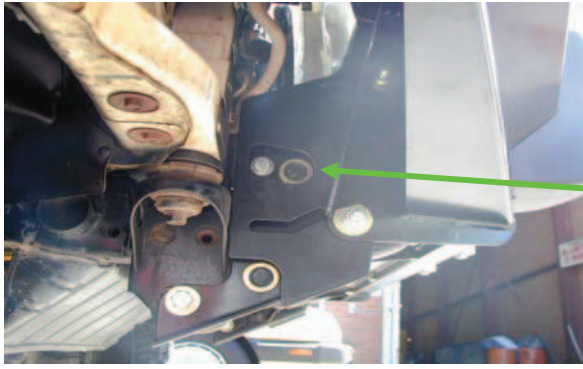

PHOTO OF RHS OF VEHICLE.



30. Fit M12 x 40mm bolts, spring washers and heavy-duty flat offset washers through bull bar side mounting holes into original bumper bar captive nut mounting holes. (Do not Tighten)

31. Fit M12 x 40mm bolt (passenger's side) & M12 x 35mm bolt (driver's side), 1/2" flat washers, heavy duty flat washers, spring washers and 12mm nuts to lower bull bar mounting holes and vehicle tie down plates. (Do not Tighten)

NOTE: Insert bolt from outside of lower mount hole so heavy-duty washer covers large hole on tie down plate.

32. Adjust the bull bar to achieve a uniform gap to the grill and mudguards. If additional height adjustment is required, the M12 bolts fitted at step 5 may be loosened for additional adjustment. Tighten all the fitted bolts, including those fitted at step 5, to a torque of 77Nm or 80 ft.lbs.



33. Once the bar is secured to the vehicle, using the 10mm holes in chassis bracket as template, drill 10mm hole through side of chassis and secure using M10 x 40mm bolt, two flat washer per bolt, spring washer and nut. Carry out this procedure on both sides of vehicle.

10MM BOLT LOCATION



12MM LOCK NUT
(TIGHTEN AGAINST BULL BAR)

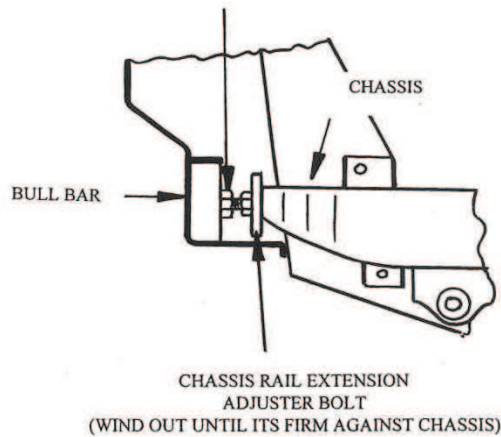

34. Wind each impact absorber adjuster bolt out until it is firm against the chassis rail extensions and tighten the lock nut.



35. Assemble and install combination light surrounds (p/n 3163015) as per instructions no. 3786421 supplied with surround kit. Note: Optional fog lamps can be installed at this point as per fitting instruction no. 3783315 supplied with fog lamp kit no. 6821201.

Wire the combination lamp to the vehicles indicator and clearance lamps.

Caution: Cable tie all cables together and keep all cables clear of sharp edges and moving parts.

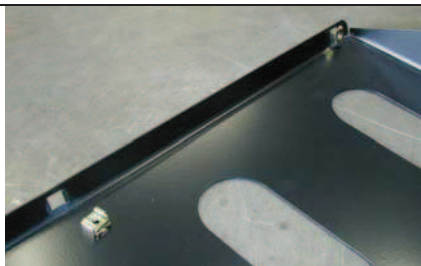

36. Air deflector assembly:
Fit three M6 cage nuts to the upper deflector panel as shown on the left.

For non-4.8 litre petrol engine vehicles, assemble the second deflector panel using M6x16mm bolts, washers and flange nuts as shown on the left.

4.8 litre petrol engine vehicles only require the upper panel to be fitted to the vehicle.

M6x16 bolts fit through these slots when fitting to the vehicle



37. Fit the air deflector / deflectors using M6 nuts and bolts.

Fit three M6x16 bolts and washers through the front of the upper deflector into the cage nuts previously installed.

Fit two M6x16 bolts, through the two slots on each side of the deflector, with washers and flange nuts to fasten the deflector to the mating impact absorbers. These slots are accessible through the cut-outs in the deflector.



38. If fitting optional driving lights to vehicle do so at this stage, use the lower cutouts in the bar to access with the ratchet and extension to tighten lights to bar.



39. Fit number plate to bar using M6x16 bolts, washers and flange nuts. The two photos display the number plate positions for winch and non-winch bars.

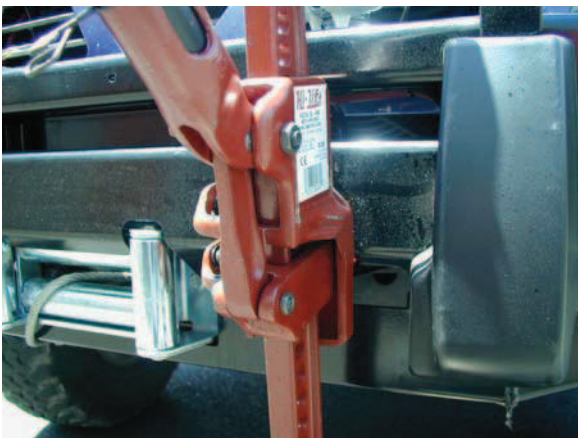

40. Provision for high-lift jack on both sides of bar.